

Other CruzPro Products

- Depthsounders & Speed/Temperature/Log
- DC Volts/Amps/Amp-Hour Monitor
- AC Volts/Amps/Freq/kW Monitor
- LPG/Petrol Gas Detectors/Alarms
- Bilge Water Alarms & Bilge Pump Controllers
- Windlass Controller/Chain Counter
- Digital Fuel Gauges & Fuel Consumption Calculator
- Digital Gauges for 1 & 3 Tanks /w Separate Alarms
- Smart and Manual Alternator Regulators
- Marine Security System
- RPM/Engine Hours/Elapsed Time Gauge
- Digital Oil Pressure Gauge/Alarm
- Digital Water Temperature Gauge/Alarm
- One and Three Bank Digital Volts Gauges
- Digital Amps Gauge
- Digital Clock/Watch/Race Timers/Alarms
- 8 and 16 Amp Light Dimmers / Motor Speed Controller
- Solar Panel Charge Controllers 6/8/9 & 20 Amps
- 4 & 8 Channel NMEA Combiners/RS-232 Convertors
- Engine/Exhaust Temp. Monitor & Digital Pyrometer
- Remote Digital NMEA 0183 Data Repeater

CruzPro®
PR60



Digital Pressure Gauge/Alarm

Notes

Introduction

The PR60 Digital Pressure Gauge provides an accurate display of pressure. Pressure can be displayed up to 6550 units (PSI or Bars) or as a percentage (0 to 100%). The PR60 is pre-programmed for use with all popular American and European resistive pressure senders made by VDO, Teleflex, Mercury, GM, Stewart-Warner, Centroid, Faria and others. Custom 0-5V and 4-20mA versions are also available by special order. Low and High level alarms can be set over the entire range of the instrument/sender. When activated, the built-in 85 dB alarm will sound and the display will flash. Five levels of backlighting can be selected and all set-up, alarm values, sender type and maximum tank capacity are saved in a non-volatile memory. The PR60 outputs NMEA 0183 serial data or this output pin can be programmed to activate an external alarm.

Table of Contents

Notes

Introduction	3
Specifications	4
Installation	5
Mounting and Wiring	6
Operation	8
Key Functions	8
Backlight Intensity	8
Setting Low/High Level Alarms	9
Alarms On/Off	9
Displaying Pressure	10
Selecting Sender Type	11
Setting Maximum Tank Capacity	12
Selecting NMEA 0183 or External Alarm Output	13
Other CruzPro Products	16

©2016 BV Engineering PR60MAN-A
<http://www.cruzpro.com> info@cruzpro.com

Specifications

Power supply: 9.5 to 33.0 VDC, .035 amps nom.
Operating temperature: 32 to 122 F (0 to 50 C)
Size: 2.5" dia X 4.1" deep (61mm x 104 mm)
Accuracy: Limited only by sender accuracy
Senders: Works with 0-30, 0-70, 0-90, 10-73, 10-180, 33-240, 40-250 ohm resistive senders by VDO, Teleflex, GM, Stewart-Warner, Mercury, Faria, and others (both American and European styles). Custom versions available for 0-5V and 4-20mA senders.
Alarms: 85 db internal Low and High level alarms, settable from 000.0 to 6553. External alarm output.
Display: 4 digits, PSI, Bars or %, 000.0 to 6553. Five levels of backlighting.
Data output: NMEA 0183 4800 baud serial output of pressure. \$IIXDR sentence or programmable as an external alarm output.

Selecting NMEA 0183 or External Alarm Output

To toggle Screw Terminal Pin (C) between NMEA 0183 and External Alarm Output, press and hold down both the ▼ and ▲ keys for 10 seconds (until you hear a long beep). The new output mode is automatically saved to memory. When the external alarm output is activated, a 5V signal (10 mA Max.) is output on screw terminal (C).

Setting Maximum Pressure Range

Press and hold down the **+** key for 10 seconds (until you hear a long beep.) Use the **▼** and **▲** keys to set the maximum pressure for your pressure sender, either in PSI or Bars. Once the maximum pressure is showing on the display, press the **+** key for 1/2 second to save this value into memory.

Page 12

Installation

Before starting the installation, please read this entire section first. Be sure to install the bulkhead gasket before you install the instrument. Finger tighten the screws that mount the instrument bracket - do not use tools.

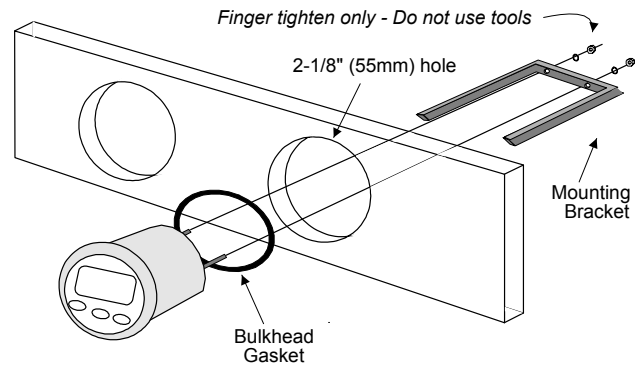

Figure 1

Page 5

Displaying Pressure

Press the **+** key to display pressure (PSI or Bars).
Press the **▲** key to display pressure in percent (0 to 100%).

Page 10

driver to make the connections to the screw terminal on the instrument case back as shown in figure 2.

- Carefully check all your wiring against those shown in figure 2. If everything is wired correctly you can mount the PR60 in the instrument hole. Be sure the bulkhead gasket is in place and use only finger tension to tighten the bracket hold-down nuts. *Do not overtighten the bracket or you may damage the case - do not use tools to tighten the nuts.*

Page 7

Mounting and Wiring

- Drill a 2-1/8" (55mm) mounting hole where you desire to mount the instrument (Figure 1).
- Bring the sender wires, ground, and power lines out of the mounting hole and use a small flat screw-

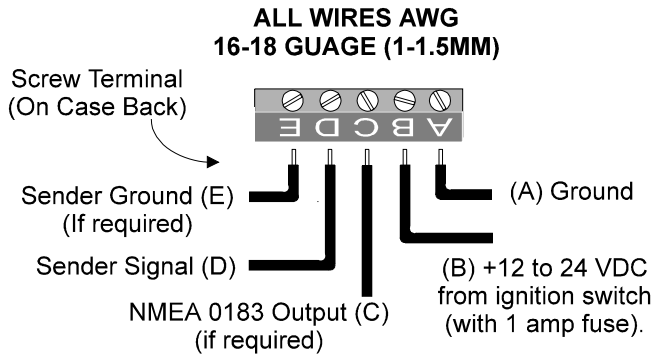



Page 6

Figure 2

Operation

Key Functions



The    keys are used to select backlight levels, display pressure (PSI, Bars or percent), set the low/high level alarms, select sender type and set the maximum sender pressure. After changes are made, the new information is automatically saved to memory.

Backlight Intensity

Press the  key for 1/2 second to adjust the backlight level for night-time viewing. Each time you press the "+" key for 1/2 second, the backlight level will change: 1, 2, 3, 4, OFF, 1, 2, ... etc.

Page 8





Selecting Sender Type

Press and hold down both the  and "+" keys for 10 seconds (until you hear a long beep.) Use the  and  keys to select the correct sender from the list below. Once the correct sender has been chosen, press the "+" key for 1/2 second to save your entry.

U- 1	0-30 Ohm	U-10	90-0 Ohm
U- 2	0-70 Ohm	U-11	73-10 Ohm
U- 3	0-90 Ohm	U-12	180-10 Ohm
U- 4	10-73 Ohm	U-13	240-33 Ohm
U- 5	10-180 Ohm	U-14	250-40 Ohm
U- 6	33-240 Ohm	U-15	0-5 Volts
U- 7	40-250 Ohm	U-16	5-0 Volts
U- 8	30-0 Ohm	U-17	4-20 mA
U- 9	70-0 Ohm		

Page 11

Setting Low/High Level Alarms

While viewing pressure, press and hold the  or  key for ten (10) seconds to view/set the Low or High pressure alarms. You will hear a long beep and the alarm value is displayed. Press the  and  keys to set the desired alarm limit (000.0 to 6553 PSI or Bars). Press the "+" key for 1/2 second to save your entry to the non-volatile memory.

Alarms ON/Off



Press the  or  key for 1/2 second to "arm" or "disarm" the level alarms. The display will flash "On" or "OFF" briefly to show you the state of the alarms. You should leave the alarms armed at all times and only disarm it to silence the alarm buzzer.

Figure 1

Page 9